















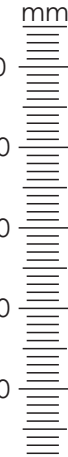
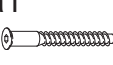

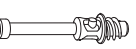
№	Обозначение	Наименование	Размеры детали, мм.			Кол.
			длина	ширина	толщина	
1	КН.НМ.54.12.00.01.00	Крышка	1414	562	16	1
2	КН.НМ.54.12.00.02.00	Стенка горизонтальная	1414	560	16	1
3	КН.НМ.54.12.00.03.00	Стенка вертикальная	1918	560	16	1
4	КН.НМ.54.03.00.04.00	Стенка вертикальная	1918	560	16	1
5	КН.НМ.54.12.00.05.00	Стенка вертикальная	1918	540	16	1
6	КН.НМ.54.12.00.06.00	Стенка вертикальная	1374	120	16	1
7	КН.НМ.54.03.00.07.00	Стенка вертикальная	524	120	16	1
8	КН.НМ.54.03.00.08.00	Стенка вертикальная	524	120	16	1
9	КН.НМ.54.12.00.09.00	Стенка вертикальная	1340	120	16	1
10	КН.НМ.54.12.00.10.00	Стенка вертикальная	912	128	16	1
11	КН.НМ.54.03.00.11.00	Дверь ПВХ	1912	456	16	1
12	КН.НМ.54.03.00.12.00	Дверь ПВХ	1912	456	16	1
13	КН.НМ.54.12.00.13.00	Дверь ПВХ	1912	456	16	1
14	КН.НМ.54.12.00.14.00	Стенка горизонтальная	452	540	16	1
15	КН.НМ.54.12.00.15.00	Полка	450	538	16	3
16	КН.НМ.54.12.00.16.00	Стенка горизонтальная	912	540	16	1
17	КН.НМ.54.12.00.17.00	Стенка задняя ДВП	1947	466	2,5	2
18	КН.НМ.54.12.00.18.00	Стенка задняя ДВП	1947	474	2,5	1
19		Профиль соединительный	1915			1
20		Штанга овальная	906			1

 g7 1шт.	 e5 8шт.	 k3 4шт.	 n1 2шт.	 e2 4шт.	 b4 2шт.	
 a1 22шт.	 a3 1шт.	 a2 18+4шт.	 b1 12шт.	 b2 16шт.	 b3 12+4шт.	
 d2 3,5x16 120шт.	 e3 8шт.	 i2 8шт.	 i1 12шт.	 h2 3шт.	 f1 10шт.	

Важно: внешний вид фурнитуры может отличаться от указанного!!!

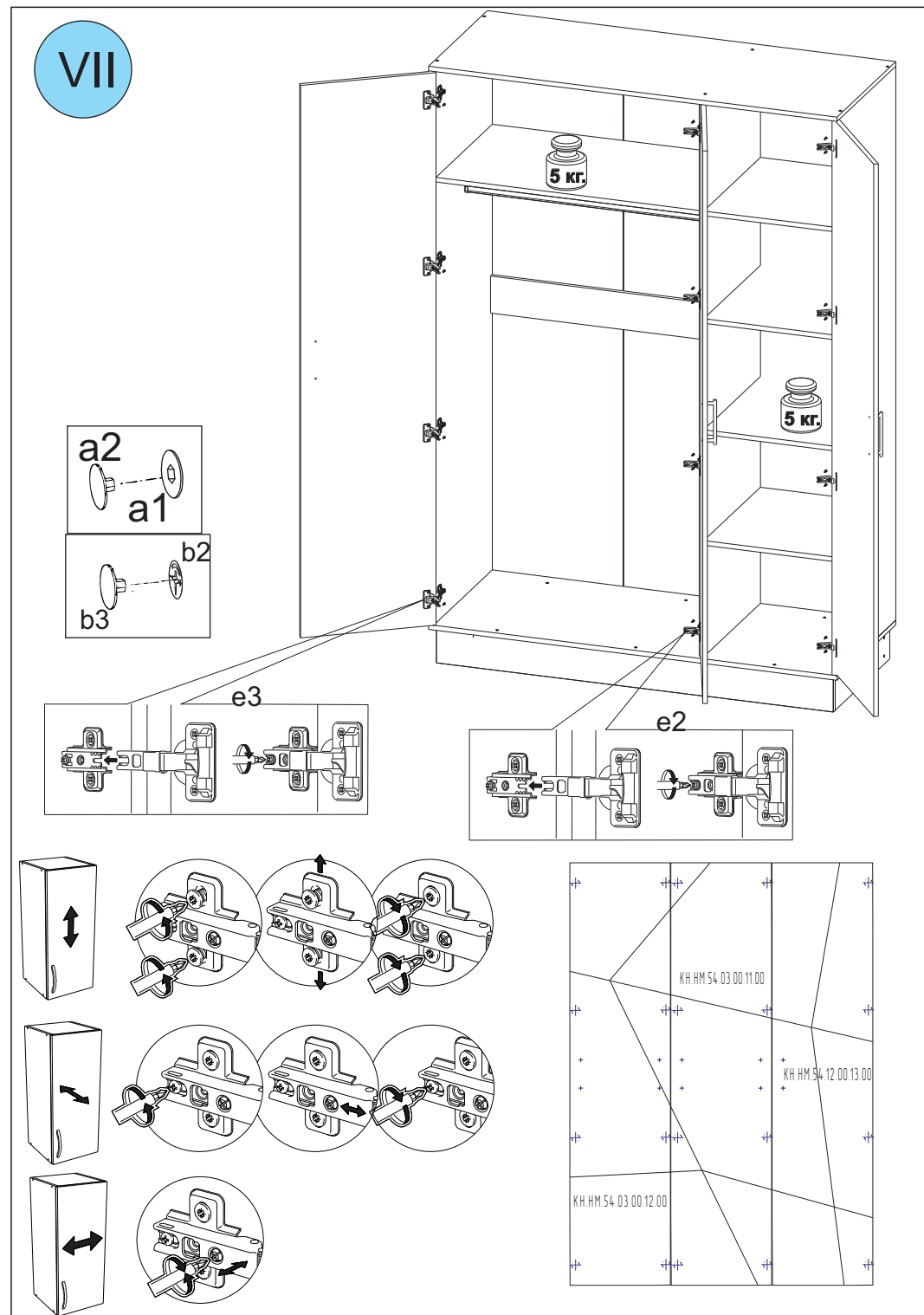

V

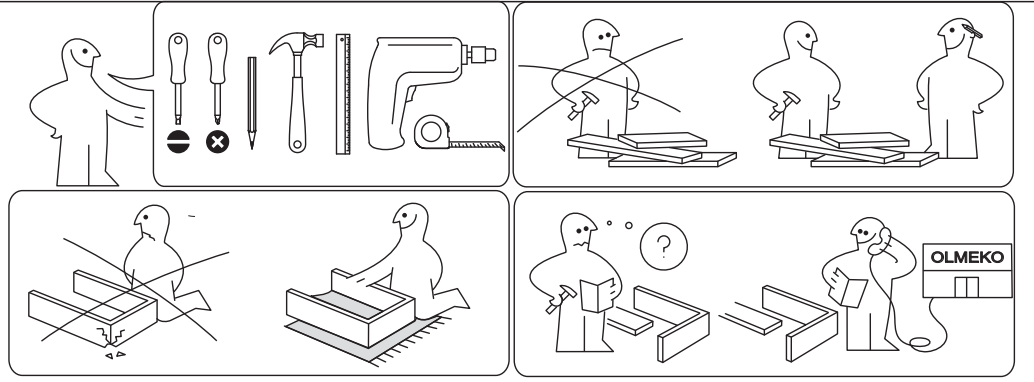
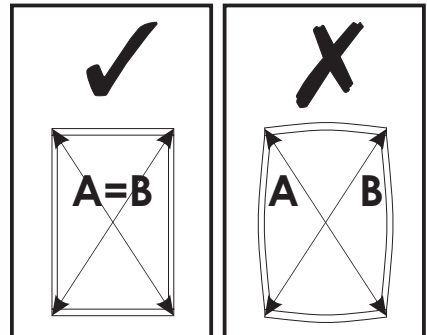
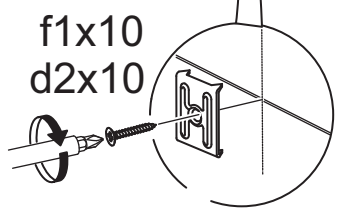
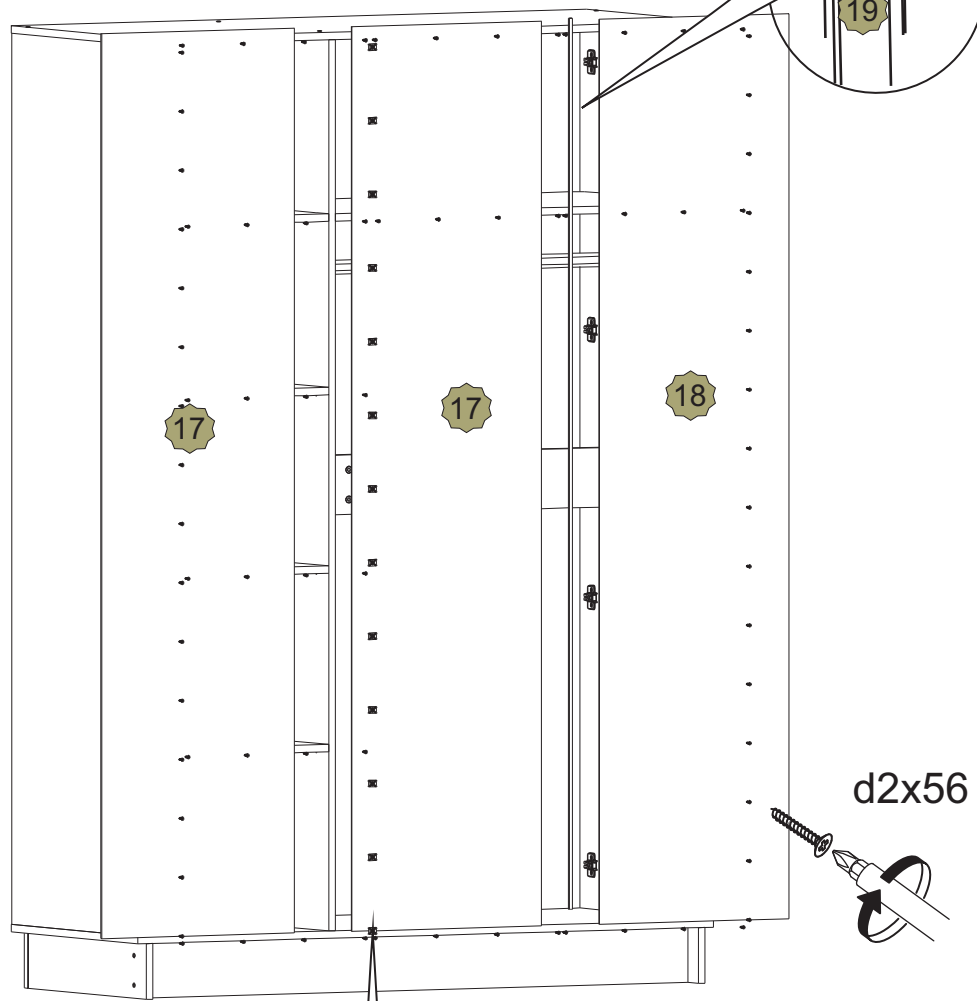

I

